

GLAND PACKING



Model	Main constituent materials	Performance				pH range	Color	Ref. page
		Valve			Manhole			
		Fluid temperature (°C)	Maximum operating pressure (MPaG)	Maximum pressure class	Fluid temperature (°C)			
EDP15P	Flexible graphite	-270 to 455 *1	43.1	2500		0 to 14	Black	7
No.6617+No.6710	Flexible graphite	-270 to 650 *2	77.6	4500		0 to 14	Black	7
No.6617-CL+No.6710CL	Flexible graphite	-270 to 455 *1	77.6	4500		0 to 14	Black	8
No.6617-CL+No.6720	Flexible graphite	-270 to 455 *1	15.5	900		0 to 14	Black	8
No.6315CL	Flexible graphite	-270 to 455 *1	15.5	900		0 to 14	Black	10
No.6315CN	Flexible graphite	-270 to 400 *1	15.5	900		0 to 14	Black	10
No.6315CH	Flexible graphite	-270 to 650 *2	25.9	1500		0 to 14	Black	10
No.6610CL	Flexible graphite	-270 to 455 *1	77.6	4500		0 to 14	Black	9
No.6610CN	Flexible graphite	-270 to 400 *1	77.6	4500		0 to 14	Black	9
No.6610CH	Flexible graphite	-270 to 650 *2	77.6	4500		0 to 14	Black	9
No.6610	Flexible graphite	-270 to 650 *2	43.1	2500		0 to 14	Black	9
No.6616CL	Flexible graphite	-270 to 455 *1	77.6	4500		0 to 14	Black	9
No.6616CN	Flexible graphite	-270 to 400 *1	77.6	4500		0 to 14	Black	9
No.6616CH	Flexible graphite	-270 to 650 *2	77.6	4500		0 to 14	Black	9
No.6616	Flexible graphite	-270 to 650 *2	43.1	2500		0 to 14	Black	9
No.6710CL	Flexible graphite	-270 to 455 *1	77.6	4500		0 to 14	Black	9
No.6710CN	Flexible graphite	-270 to 400 *1	77.6	4500		0 to 14	Black	9
No.6710CH	Flexible graphite	-270 to 650 *2	77.6	4500		0 to 14	Black	9
No.6710	Flexible graphite	-270 to 650 *2	77.6	4500		0 to 14	Black	9
No.6720	Flexible graphite	-270 to 455 *1	15.5	900		0 to 14	Black	8
No.6711	Flexible graphite	-270 to 650 *2	25.9	1500		0 to 14	Black	11
No.6711N	Flexible graphite	-270 to 600 *2	25.9	1500		0 to 14	Black	11
No.6114-M	Flexible graphite				0 to 400	0 to 14	Black	12
No.6114	Flexible graphite	-270 to 400 *1	5.2	300		0 to 14	Black	12
No.6650	Flexible graphite	-270 to 650 *2				0 to 14	Black	12
No.6528	Carbon fiber	-200 to 500	43.1	2500		0 to 14	Black	11
No.4519	PTFE fiber	-29 to 260	10.3	600		0 to 14	White	10
No.385	Inorganic fiber + Stainless steel fiber	0 to 800	1			0 to 14	Black	11
No.388	Mica	0 to 800	1			0 to 14	Brown	11

Model	Main constituent materials	Performance														pH range	Color	Ref. page	
		Pump				Valve			Plunger pump				Low-speed rotary machine						
		Fluid temperature (°C)	Maximum operating pressure (MPaG)	Peripheral velocity (m/s)	Allowable PV value (MPaG·m/s)	Fluid temperature (°C)	Maximum operating pressure (MPaG)	Maximum pressure class	Fluid temperature (°C)	Maximum operating pressure (MPaG)	Peripheral velocity (m/s)	Allowable PV value (MPaG·m/s)	Fluid temperature (°C)	Maximum operating pressure (MPaG)	Peripheral velocity (m/s)				
No6501L	Carbonized fiber	0 to 200 *3	1	20 max.	9.8												2 to 12	Black	15
No6502L	Carbonized fiber	0 to 200 *3	1.2	10 max.	9.8												2 to 12	Black	15
No6521L	Carbonized fiber	0 to 200 *3	1.2	20 max.	9.8												2 to 12	Black	15
No6507	Carbon fiber					-200 to 260	10.3	600					260 max.	3.9	1 max.		0 to 14	Gray	20
No6527	Carbon fiber												350 max.	3.9	1 max.		0 to 14	Black	16
No6527L	Carbon fiber	0 to 350 *3	1.6	10 max.	9.8								350 max.	3.9	1 max.		0 to 14	Black	16
No6527S	Carbon fiber								-200 to 300 *3	29.4	1.2 max.	24.5 max.					0 to 14	Black	16
No6615	Flexible graphite	0 to 350 *3	2	20 max.	24.5												0 to 14	Black	21
No6722	Flexible graphite					-200 to 350	10.3	600					350 max.	3.9	1 max.		0 to 14	Black	21
No6733	Flexible graphite	0 to 350 *3	2	20 max.	19.6												0 to 14	Black	21
No4504	PTFE fiber					0 to 200	10.3	600									0 to 14	White	18
No4505L	PTFE fiber	0 to 260 *3	1	10 max.	4.9	-29 to 260	10.3	600									0 to 14	White	19
No4525	PTFE fiber					-29 to 260	10.3	600					260 max.	3.9	1 max.		0 to 14	White	19
No4525L	PTFE fiber	0 to 200 *3	1	10 max.	4.9								260 max.	3.9	1 max.		0 to 14	White	20
No4526L	Aramid fiber	0 to 260 *3	1.6	16 max.	14.7								260 max.	3.9	1 max.		2 to 14	Yellow	17
No4527L	PTFE fiber	0 to 260 *3	2.0	20 max.	12.3												0 to 14	Dark gray	20
No4535L	PTFE fiber	0 to 200 *3	0.8	8 max.	4.9	-29 to 260	10.3	600	0 to 200 *3	10.0	1.2 max.	12.0 max.					0 to 14	White	19
No4536W	Aramid fiber												260 max.	3.9	1 max.		2 to 13	White	17
No4536WL	Aramid fiber	0 to 260 *3	1	10 max.	6.5								260 max.	3.9	1 max.		2 to 13	White	17
No4536WL-S	Aramid fiber	0 to 260 *3	1	10 max.	6.5												2 to 13	White	17
No4536	Aramid fiber					0 to 200	10.3	600					200 max.	3.9	1 max.		2 to 14	Light yellow	18
No4536L	Aramid fiber	0 to 200 *3	1	16 max.	10												2 to 14	Light yellow	18
No426	Hemp	0 to 80	0.5	10 max.	2.5												6 to 8	Ivory	22
No426F	Hemp	0 to 80	0.6	10 max.	3.4												6 to 8	Ivory	22

*1 The temperature of the packing must be no more than 350°C.

*2 When the packing is used in an oxidizing atmosphere, its temperature must be no more than 450°C.

*3 Any fluid exceeding +80°C must be cooled.

General valves

(Fluid classification) Water (hot water/oil), solvents, corrosive fluids (weak acid), corrosive fluids (weak alkali), nonflammable gases, flammable gases, toxic gases, liquefied gases, powder (slurry/resin)

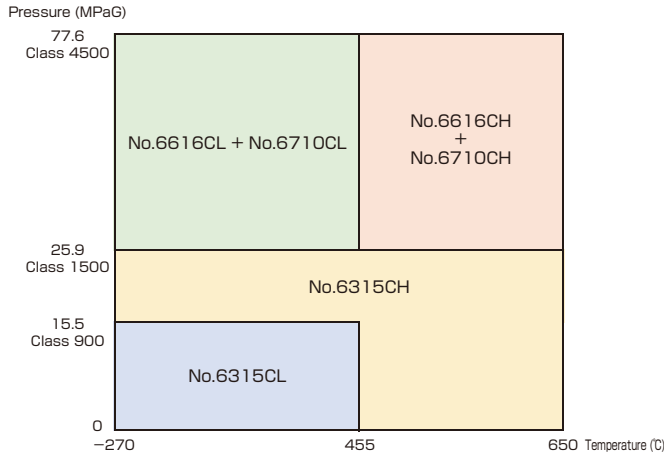

High-frequency valves

(Fluid classification) Water (hot water/oil), solvents, corrosive fluids (weak acid), corrosive fluids (weak alkali), nonflammable gases, flammable gases, toxic gases, liquefied gases, powder (slurry/resin)

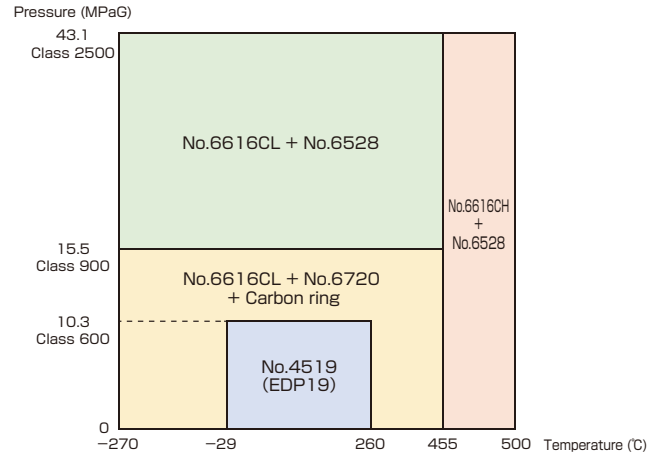

General valves and high-frequency valves

(Fluid classification) Corrosive fluids (strong acid) and corrosive fluids (strong alkali)

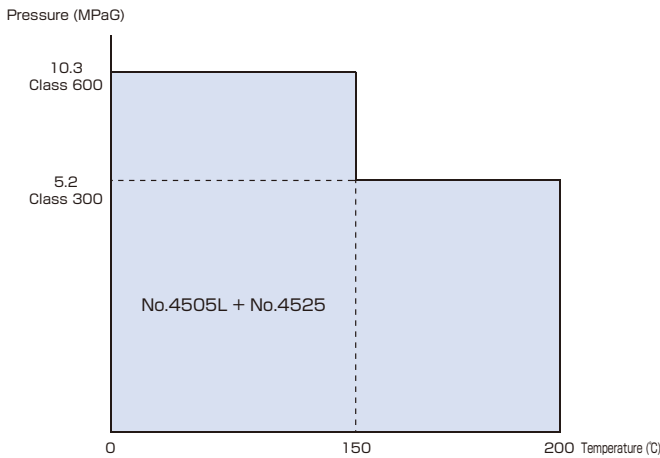

General valves and high-frequency valves

(Fluid classification) Combustion-supporting gases (oxygen), clean fluids

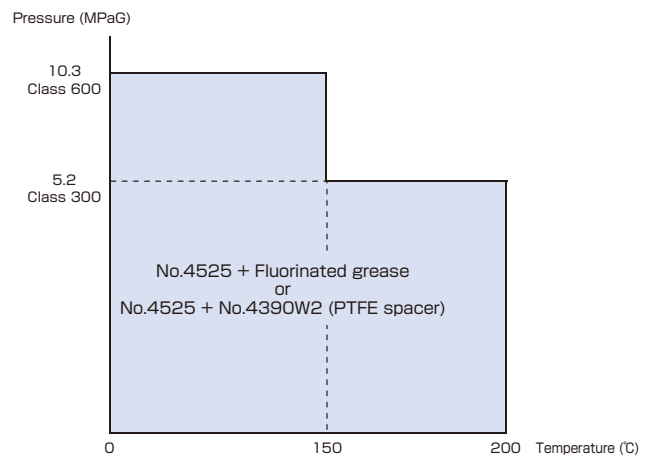

General valves

(Fluid classification) Exhaust gas

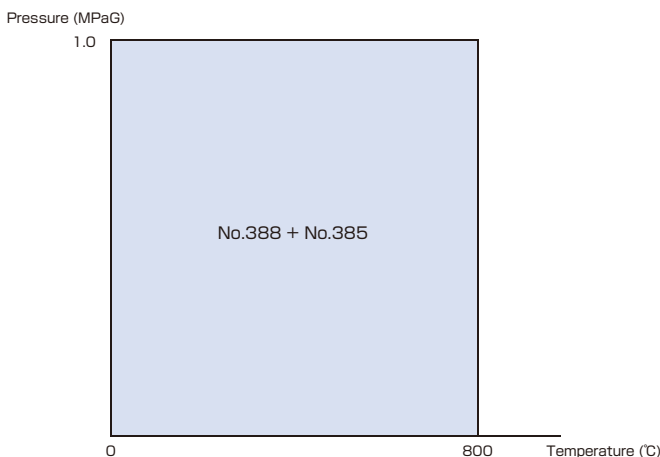

Low Emission Valve (General valves)

(Fluid classification) Water (hot water/oil), solvents, corrosive fluids (weak acid), corrosive fluids (weak alkali), nonflammable gases, flammable gases, toxic gases, liquefied gases, powder (slurry/resin)

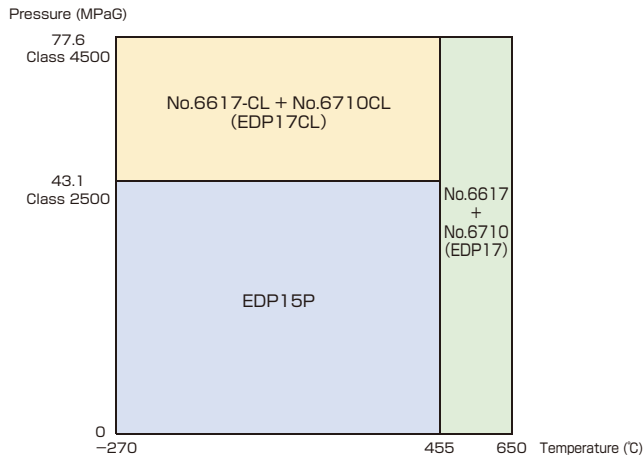

Low Emission Valve (High-frequency valves)

(Fluid classification) Water (hot water/oil), solvents, corrosive fluids (weak acid), corrosive fluids (weak alkali), nonflammable gases, flammable gases, toxic gases, liquefied gases, powder (slurry/resin)

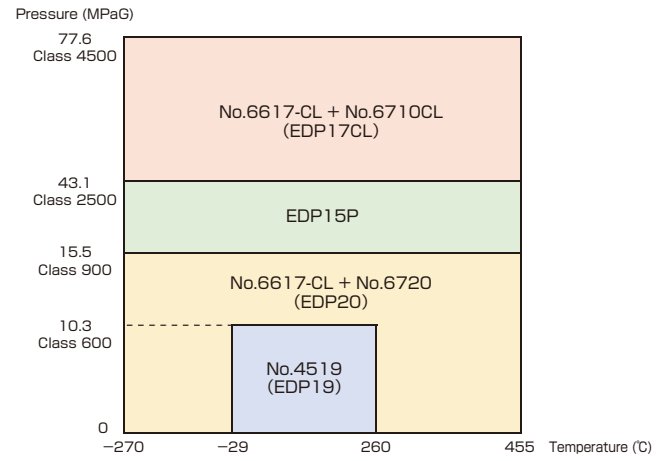

Valve gland packing combination methods and standard number of rings

Pressure class	When combination packing sets are used	When single packings are used
150 300		
600 900 1500		
2500		
Over 2500		<p>Legend</p> <ul style="list-style-type: none"> Seal packing (No.6616, No.6616CL, No.6616CH, etc.) Adapter packing (No.6710, No.6710CL, No.6710CH, etc.) Single packing (No.6315CL, No.6315CH, etc.) Lantern ring

Pump

(Fluid classification) Water (hot water, oil)

Pressure (MPaG)

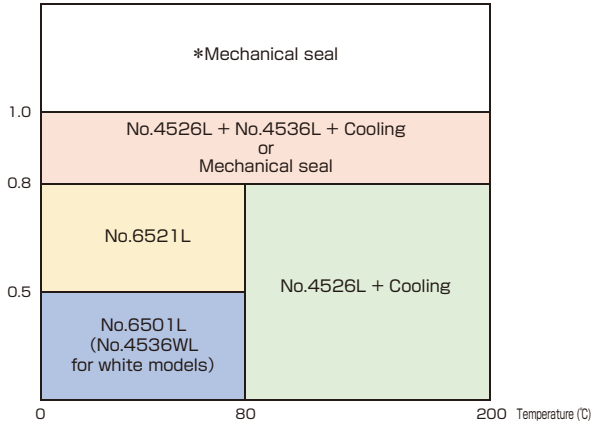

Pump

(Fluid classification) Powder (slurry/resin)

Pressure (MPaG)

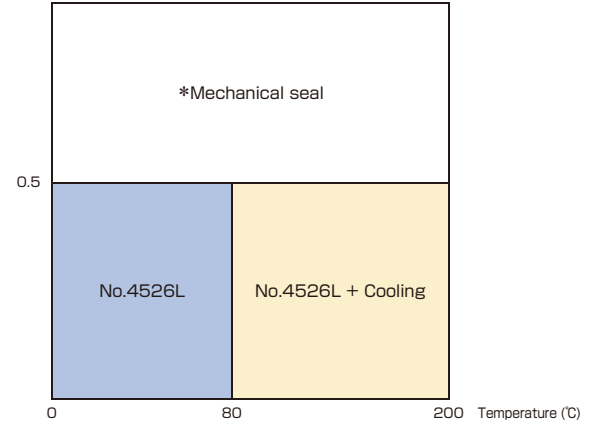

Pump

(Fluid classification) Solvents

Pressure (MPaG)

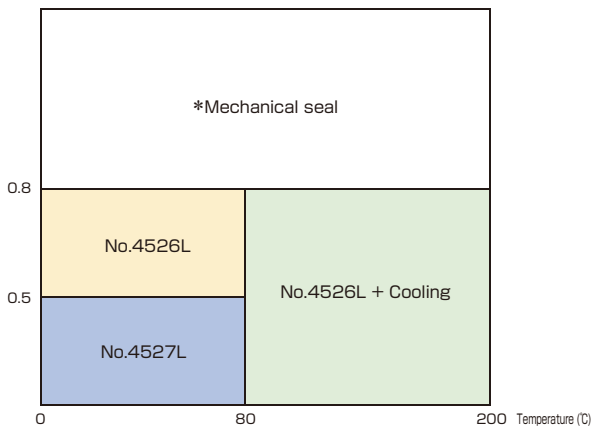

Pump

(Fluid classification) Clean fluids

Pressure (MPaG)

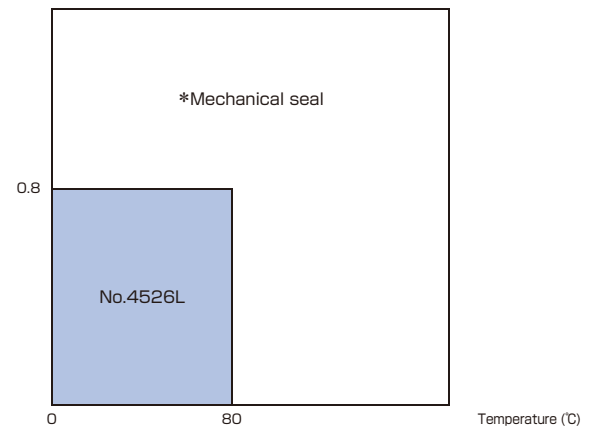

Pump

(Fluid classification) Corrosive fluids (weak acid), corrosive fluids (weak alkali), corrosive fluids (strong acid), and corrosive fluids (strong alkali)

Pressure (MPaG)

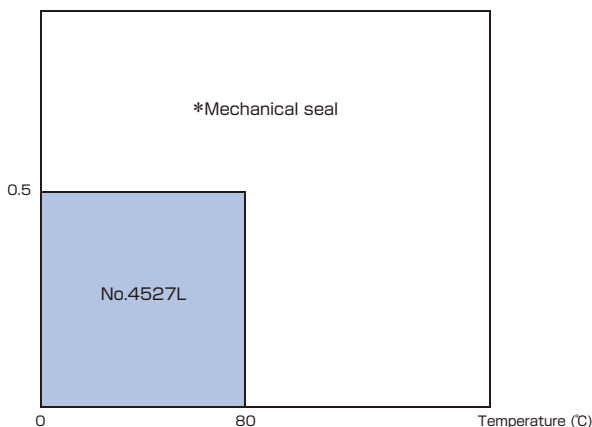

Plunger pump

(Fluid classification) Water (hot water/oil), solvents, corrosive fluids (weak acid), and corrosive fluids (weak alkali)

Pressure (MPaG)

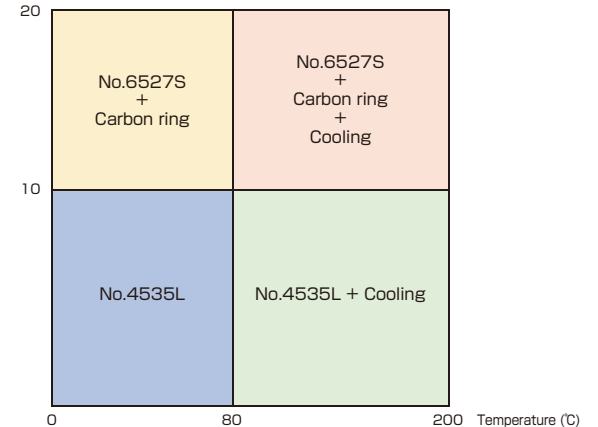

Low-speed rotary machine

(Fluid classification) Water (hot water/oil), solvents, corrosive fluids (weak acid), corrosive fluids (weak alkali), nonflammable gases, flammable gases, exhaust gas, and powder (slurry)

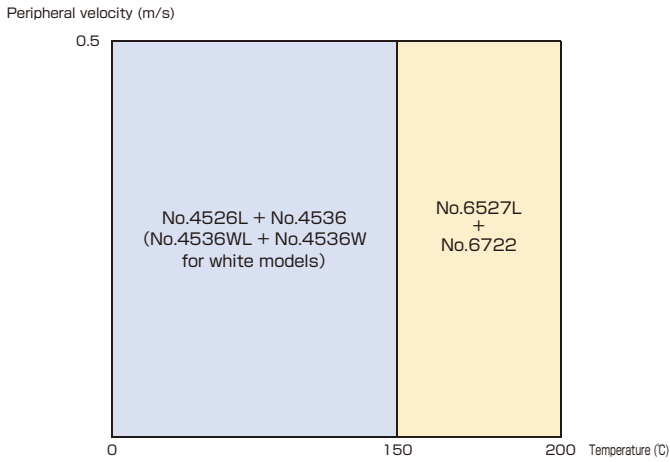

Low-speed rotary machine

(Fluid classification) Corrosive gases

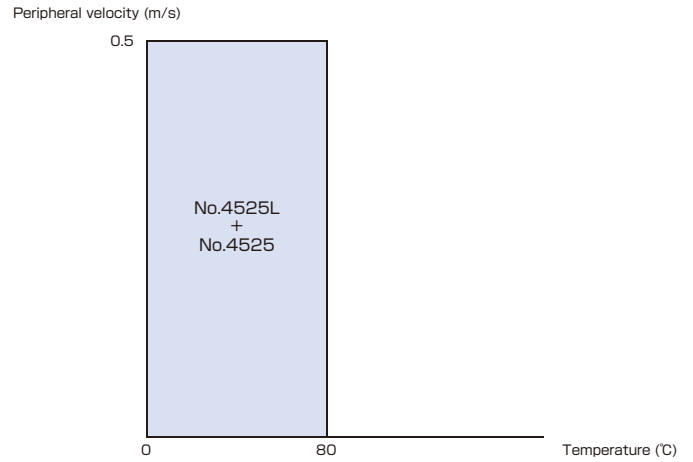

Low-speed rotary machine

(Fluid classification) Corrosive fluids (strong acid) and corrosive fluids (strong alkali)

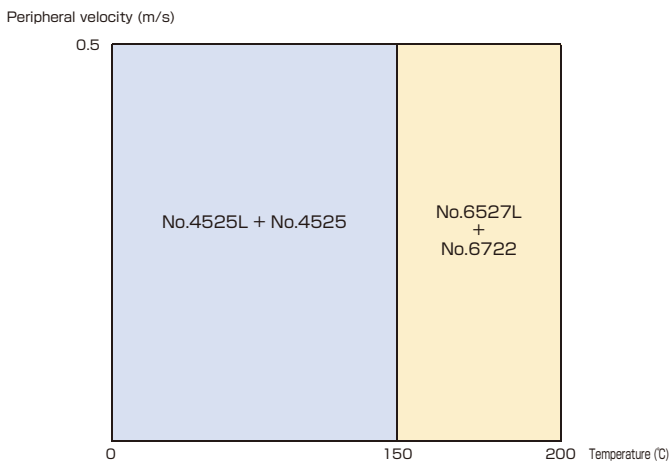

Low-speed rotary machine

(Fluid classification) Resin

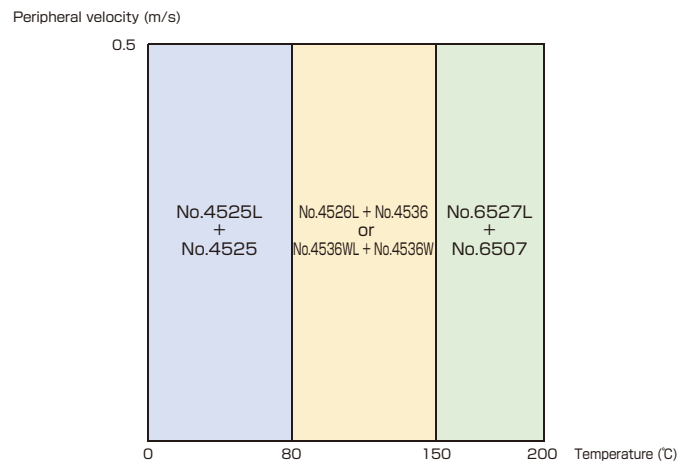

Low-speed rotary machine

(Fluid classification) Toxic gases

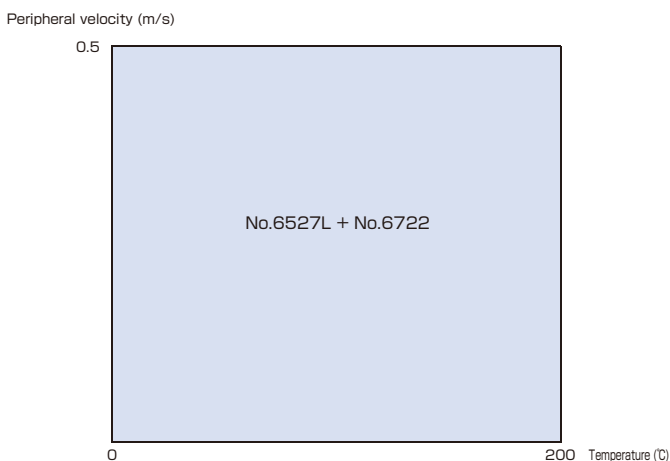

Low-speed rotary machine

(Fluid classification) Clean fluids

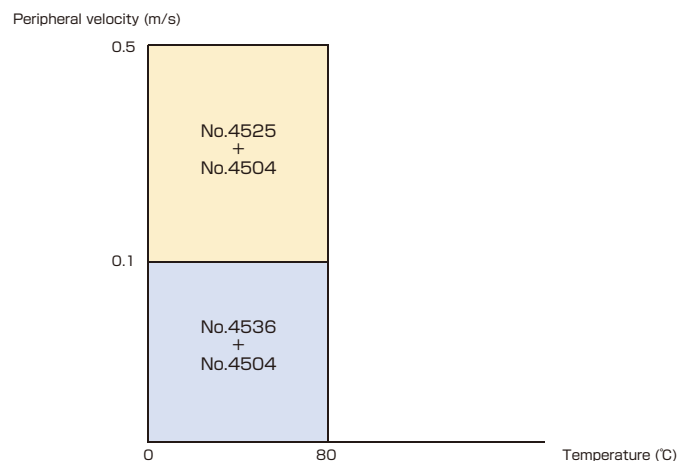

No.6617 + No.6710

EDP17 PILLARFOIL™ packing set for high-temperature, high-pressure valves



This packing set combines seal packing (No. 6617) that is integrally molded by combining molded parts of flexible graphite sheets and laminated parts of flexible graphite, and adapter packing (No. 6710) that is manufactured by braiding flexible graphite yarn reinforced with nickel alloy thread.

- High airtightness performance that complies with various environmental regulations such as API 622
- Best suited for high-temperature, high-pressure valves

API Standard 622 certified

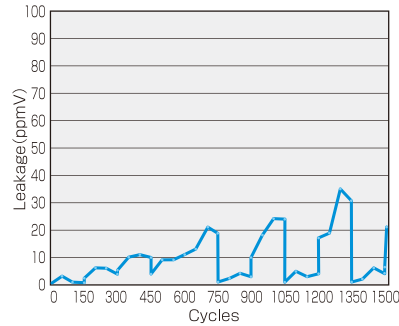

Seal packing No.6617

Adapter packing No.6710

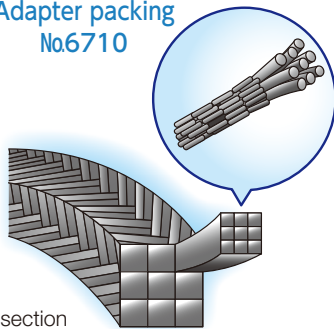
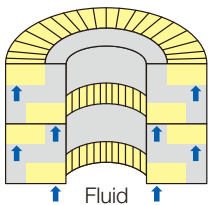

□ : Impervious treatment section

Specification conditions

Valve			pH range
Fluid temperature	Maximum operating pressure	Pressure class	
-270 to +650°C*	77.6MPaG	Class 4500 or lower	0 to 14

* When the packing is used in an oxidizing atmosphere, its temperature must be no more than 450°C.

EDP15P

EDP15P PILLARFOIL™ yarn braided packing for medium-temperature, medium-pressure valves



This product is gland packing that is manufactured by impregnating braided flexible graphite yarn (reinforced with nickel alloy thread using a PILLAR-original method) with PTFE dispersion and braiding over braids outside the core material of the flexible graphite yarn.

- High airtightness performance that complies with various environmental regulations such as API 622
- Excellent low-friction performance on valve stems
- Lineup of spiral forms for maintenance
- This product can be used as single packings for up to Class 2500

API Standard 622 certified

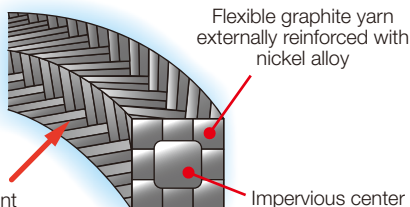
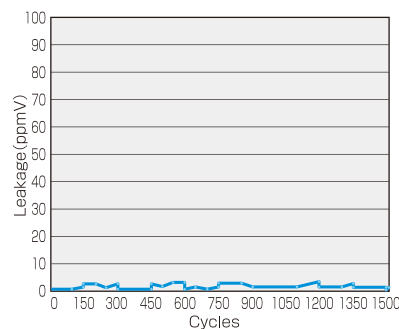

Surface treatment: Anticorrosive treatment

Flexible graphite yarn externally reinforced with nickel alloy

Impervious center core

Specification conditions

Valve			pH range
Fluid temperature	Maximum operating pressure	Pressure class	
-270 to +455°C*	43.1 MPaG	Class 2500 or lower	0 to 14

* The temperature of the packing must be no more than 350°C.

EDP17CL Low torque type PILLARFOIL™ packing set



This packing set combines seal packing (No. 6617-CL) integrally molded by combining molded parts of flexible graphite sheets and laminated parts of flexible graphite, then subjected to special lubrication treatment applying PTFE resin onto the inner circumferential surface, and adapter packing (No. 6710CL) manufactured by braiding flexible graphite yarn reinforced with nickel alloy thread using PILLAR's own original method, surfaces lubricated with PTFE resin and fine graphite powder.

- High airtightness performance that complies with various environmental regulations such as API 622
- Excellent low-friction performance on valve stems

API Standard 622 certified

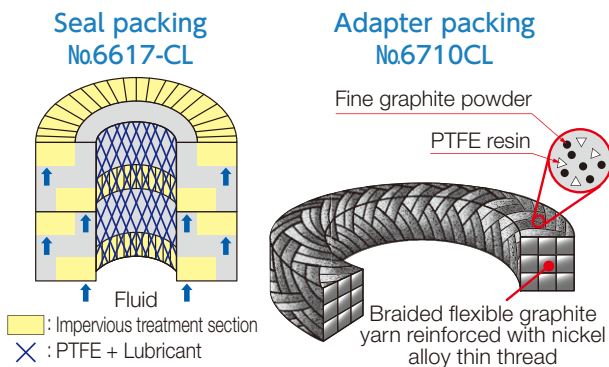
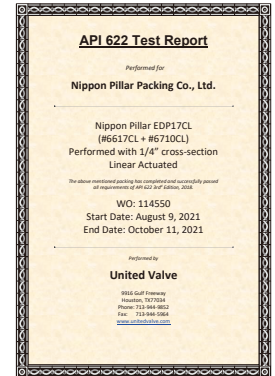
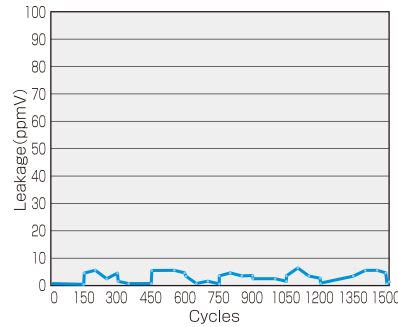

Specification conditions

Valve			pH range
Fluid temperature	Maximum operating pressure	Pressure class	
-270 to +455°C*	77.6MPaG	Class 4500 or lower	0 to 14

* The temperature of the packing must be no more than 350°C.

EDP20 PILLARFOIL™ packing set for control valves



This packing set combines seal packing (No. 6617-CL) integrally molded by combining molded parts of flexible graphite sheets and laminated parts of flexible graphite, then subjected to special lubrication treatment applying PTFE resin onto the inner circumferential surface, and adapter packing (No. 6720) manufactured by braiding flexible graphite yarn with PTFE fibers.

- High airtightness performance that complies with various environmental regulations such as API 622
- Best suited for high-frequency valves because no metal is used for reinforcement lines
- Excellent low-friction performance on valve stems

API Standard 622 certified

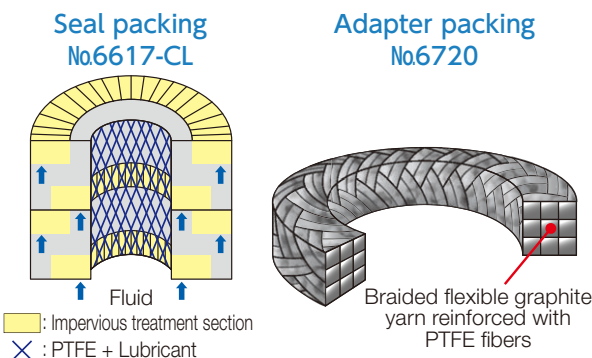
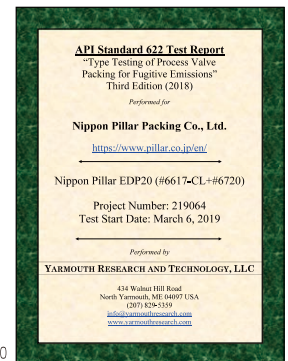
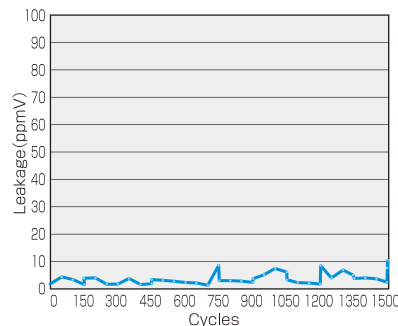

Specification conditions

Valve			pH range
Fluid temperature	Maximum operating pressure	Pressure class	
-270 to +455°C*	15.5MPaG	Class 900 or lower	0 to 14

* The temperature of the packing must be no more than 350°C.

No.6610CL + No.6710CL

Low torque type PILLARFOIL™ packing set for medium-temperature, high-pressure valves



This low-torque packing set combines seal packing (No. 6610CL) manufactured by molding flexible graphite sheets into a ring shape, then subjected to lubrication treatment applying PTFE resin and fine graphite powder onto the inner circumferential surface, and adapter packing (No. 6710CL) manufactured by braiding flexible graphite yarn reinforced with nickel alloy thread using PILLAR's own original method, surfaces lubricated with PTFE resin and fine graphite powder.

- Low torque type with excellent low-friction characteristics on valve stems
- Lineup of No. 6616CL + No. 6710CL, modified to a seal packing that combines a metal mesh that makes it easy to remove the packing
- Lineup of No. 6610CN + No. 6710CN and No. 6616CN + No. 6710CN, which control the chlorine ion concentration below 100 ppm to allow for nuclear applications

Specification conditions

Fluid temperature	Valve		pH range
	Maximum operating pressure	Pressure class	
-270 to +455°C*	77.6MPaG	Class 4500 or lower	0 to 14

* The temperature of the packing must be no more than 350°C.
* The fluid temperature of No. 6610CN + No. 6710CN or No. 6616CN + No. 6710CN is -200 to +400°C. (The temperature of the packing is below 350°C.)

No.6610CH + No.6710CH

Low torque type PILLARFOIL™ molded packing for high-temperature, high-pressure valves



This low-torque packing set combines seal packing (No. 6610CH) manufactured by molding flexible graphite sheets into a ring shape, with a special folding structure as the cross-sectional structure, and adapter packing (No. 6710CH) manufactured by braiding flexible graphite yarn reinforced with nickel alloy thread on the outer surface of a center core material that is prepared by braiding and forming thin stainless steel wire, surfaces lubricated with fine graphite powder.

- Best suited for high-temperature, high-pressure valves
- Excellent sealability, chemical resistance, and low-friction characteristics on valve stems
- Lineup of No. 6616CH + No. 6710CH, modified to a seal packing that combines a metal mesh that makes it easy to remove the packing

Specification conditions

Fluid temperature	Valve		pH range
	Maximum operating pressure	Pressure class	
-270 to +650°C*	77.6MPaG	Class 4500 or lower	0 to 14

* The temperature of the packing must be no more than 450°C.

No.6610 + No.6710

PILLARFOIL™ packing set for general valves



This packing set combines seal packing (No. 6610) manufactured by molding flexible graphite sheets into a ring shape, and adapter packing (No. 6710) manufactured by braiding flexible graphite yarn reinforced with nickel alloy thread using PILLAR's own original method.

- Lineup of No. 6616 + No. 6710, modified to a seal packing that combines a metal mesh that makes it easy to remove the packing

Specification conditions

Fluid temperature	Valve		pH range
	Maximum operating pressure	Pressure class	
-270 to +650°C*	43.1MPaG	Class 2500 or lower	0 to 14

* The temperature of the packing must be no more than 450°C.

GLAND PACKING

No.6315CL

Valve

Low torque type PILLARFOIL™ yarn braided packing for intermediate-temperature, intermediate-pressure valves



This product is a low-torque gland packing that is manufactured by braiding flexible graphite yarn reinforced with stainless steel wire using PILLAR's own original method, subjected to impervious treatment using liquid lubricant and friction reduction treatment using PTFE resin and fine graphite powder.

- This product can be used as single packings for up to Class 900
- Sealing performance and low friction performance on valve stems are balanced at a high level
- Lineup of No. 6315CN, which controls the chlorine ion concentration below 100 ppm to allow for nuclear applications

Specification conditions

Valve			pH range
Fluid temperature	Maximum operating pressure	Pressure class	
-270 to +455°C*	15.5MPaG	Class 900 or lower	0 to 14

* The temperature of the packing must be no more than 350°C.

* The fluid temperature of No. 6315CN is -200 to +400°C.
(The temperature of the packing is below 350°C.)

GLAND PACKING

No.6315CH

Valve

Manhole

Low torque type PILLARFOIL™ yarn braided packing for high-temperature, intermediate-pressure valves



This product is a low-torque gland packing that is manufactured by employing a center core composed of flexible graphite yarn and an outer layer that is braided over braids with flexible graphite yarn reinforced with stainless steel wire, then subjected to friction reduction treatment using special lubricant and fine graphite powder.

- Applicable as valve gland packings in a wide range of conditions
- Excellent usability for valve applications, thanks to stress relaxation, low friction, and other characteristics
- Lineup of spiral forms for maintenance
- This product can be used as single packings for up to Class 1500

Specification conditions

Valve			pH range
Fluid temperature	Maximum operating pressure	Pressure class	
-270 to +650°C*	25.9MPaG	Class 1500 or lower	0 to 14

* When the packing is used in an oxidizing atmosphere, its temperature must be no more than 450°C.

GLAND PACKING

No.4519

Valve

EDP19 Low torque type PILAFLON™ yarn braided packing for control valves



This product is gland packing manufactured by using carbon fiber yarn as center core material in the packing and covering the surface with PTFE fibers.

- Carbon fibers provide heat resistance and elasticity, and PTFE fibers provide chemical resistance and low sliding resistance
- Best suited for high-frequency valves and control valves
- Lineup of spiral forms for maintenance
- This product can be used as single packings for up to Class 600

Specification conditions

Valve			pH range
Fluid temperature	Maximum operating pressure	Pressure class	
-29 to +260°C	10.3MPaG	Class 600 or lower	0 to 14

No.6528

High-strength carbon fiber packing



This product is an adapter packing that is manufactured by making an interlocking braid of PAN-based carbon fibers and treating it with a small amount of binder and lubricant.

- Excellent heat resistance, chemical resistance, elasticity, and sealability
- Used in combination with No. 6610 or No. 6616

■ Specification conditions

Valve			pH range
Fluid temperature	Maximum operating pressure	Pressure class	
-200 to +500°C	43.1MPaG	Class 2500 or lower	0 to 14

No.6711

PILLARFOIL™ yarn braided packing for general valves



This product is gland packing manufactured by braiding over braids with flexible graphite yarn reinforced with nickel alloy and treating the surfaces with fine graphite powder.

- Used for high-temperature, intermediate-pressure valves
- Lineup of spiral forms for maintenance
- This product can be used as single packings for up to Class 1500
- Lineup of No. 6711N, which controls the chlorine ion concentration below 100 ppm to allow for nuclear applications

■ Specification conditions

Valve			pH range
Fluid temperature	Maximum operating pressure	Pressure class	
-270 to +650°C*	25.9MPaG	Class 1500 or lower	0 to 14

* When the packing is used in an oxidizing atmosphere, its temperature must be no more than 450°C.
* The fluid temperature of No. 6711N is -200 to +600°C. (The temperature of the packing is below 450°C.)

No.388 + No.385

Inorganic fiber packing set for high-temperature valves



This packing set combines seal packing (No. 388) manufactured by molding gold mica sheets into a ring shape, and adapter packing (No. 385) manufactured by covering (braiding) the outer circumference of the inorganic-fiber center core material with stainless steel fibers and treating them with fine graphite powder.

- Excellent chemical resistance, available for use in strong acid and strong alkaline fluids

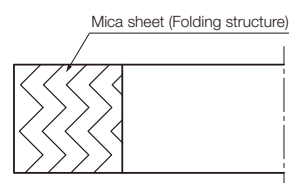
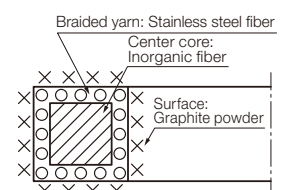
Seal packing
No.388Adapter packing
No.385

■ Specification conditions

Valve		pH range
Fluid temperature	Maximum operating pressure	
0 to +800°C	1.0MPaG	0 to 14

GLAND PACKING

No.6114

PILLARFOIL™ yarn braided packing for general valves

Valve



This is gland packing manufactured by braiding flexible graphite yarn reinforced with organic fibers and treated with special lubricant.

Specification conditions

Fluid temperature	Valve		pH range
	Maximum operating pressure	Pressure class	
-270 to +400°C*	5.2MPaG	Class 300 or lower	0 to 14

* The temperature of the packing must be no more than 350°C.

GLAND PACKING

No.6114-M

PILLARFOIL™ yarn braided packing for manholes

Manhole



This is gland packing for manholes manufactured by braiding flexible graphite yarn reinforced with organic fibers and treated with special lubricant.

- Used for manholes and maintenance hatches
- Designed to secure adaptivity and sealability with low seating stress

Specification conditions

Manhole		pH range
Fluid temperature		
0 to +400°C		0 to 14

GLAND PACKING

No.6650

PILLARFOIL™ ribbon pack

Valve



This product is a tape type free-sized packing with both surfaces of a flexible graphite sheet corrugated.

This packing is so flexible that it can be wrapped around the shaft of a valve of any size in the field and can be formed in a stuffing box. It can be used in combination with adapter packings such as No. 6710.

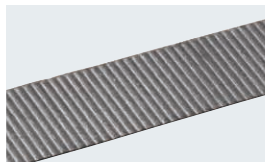

Specification conditions

Fluid temperature	pH range
-270 to +650°C*	0 to 14

* The temperature of the packing must be no more than 450°C.

PILLAR LIVE LOADING SEAL UNIT™ for low-speed rotary machines

The PILLAR LIVE LOADING SEAL UNIT maximizes the performance of gland packing to seal the shafts of low-speed rotary machines such as mixers, agitators, kneaders, and dryers, making plant operations stable.

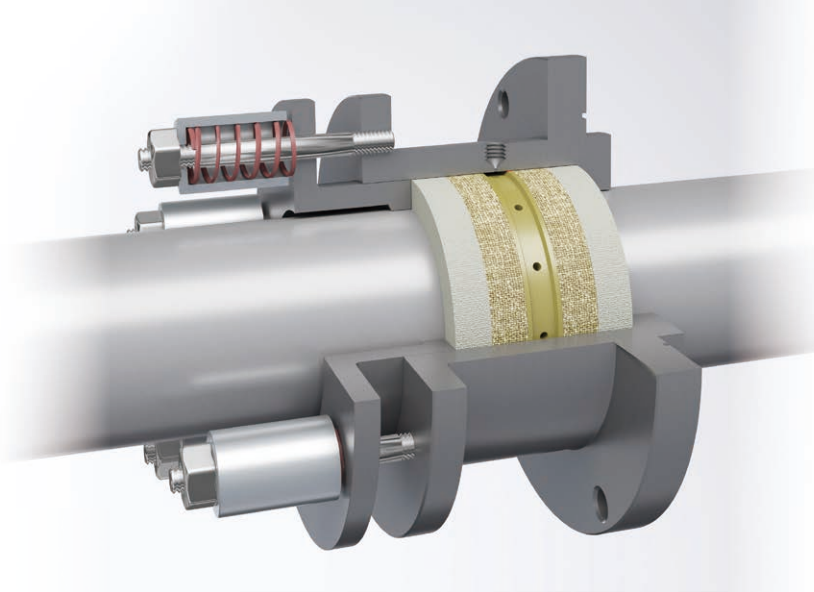

Long-lasting seal and less maintenance

The seating stress of general gland packing tends to decline quickly.

On the other hand, the Live Loading Seal (live loading method) enables stable sealability to be maintained over a long period of time by continuously applying seating stress with the spring on the gland follower to reduce the frequency of retightening.

Image of sealing device operation

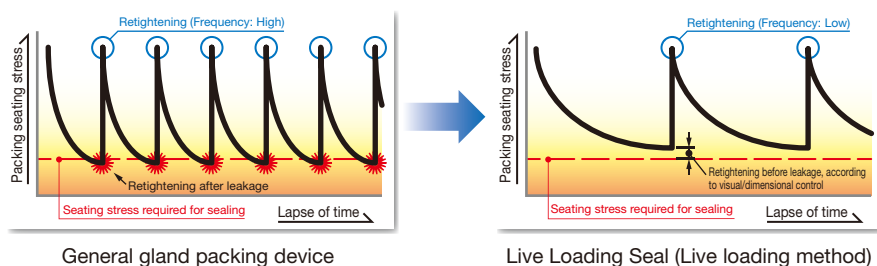

Strict sealing control → Visual/dimensional control

The Live Loading Seal Unit, designed and selected for each individual device, allows appropriate tightening to be completed just by tightening the unit until the gap between the spring collar and the gland follower reaches zero at the time of initial tightening or retightening. No special tools other than torque wrenches are required.

Moreover, measuring the gap makes it possible to identify any packing seating stress decline leading to leakage, as well as the timing of retightening.

Tighten until the spring collar comes into contact with the gland follower

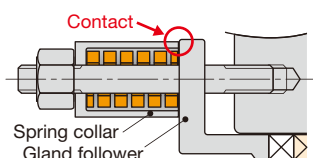

Retightening is required when the gap width reaches the length specified by PILLAR

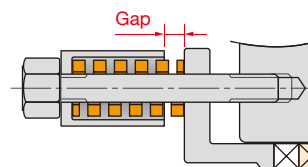

Tighten until the spring collar comes into contact with the gland follower.

PILLAR LIVE LOADING SEAL UNIT™ for low-speed rotary machines

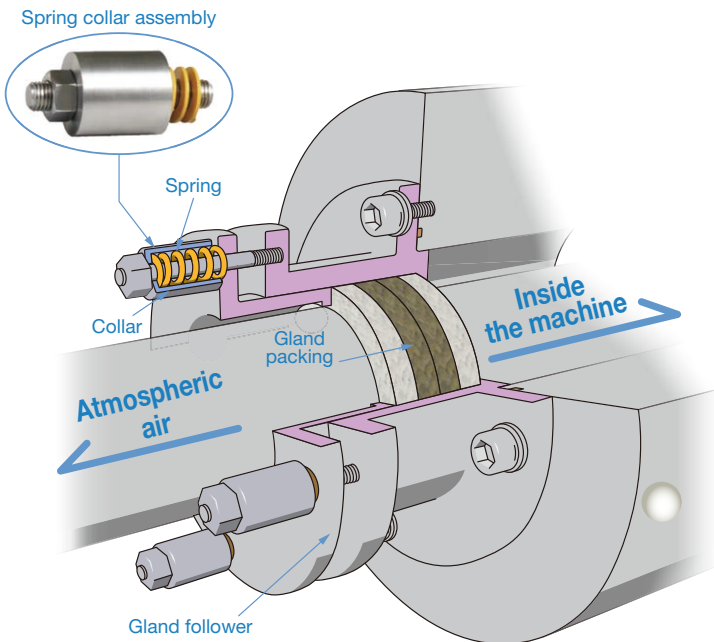

Spring pressure maintains the seating stress on the gland packing and reduces maintenance, and the spring collar visualizes the timing of tightening and tightening control.

By designing and selecting a product according to the operating conditions and combining it with a rich array of PILLAR gland packings, we can expect installation benefits such as maintenance reduction and working environment improvement.

This product is best suited for fluids such as powder or high-viscosity fluids, and low-speed rotary machines that may cause shaft runout.

* The figure above illustrates an example of Live Loading Seal Unit configurations.

Structure examples of PILLAR LIVE LOADING SEAL UNIT

Single gland type

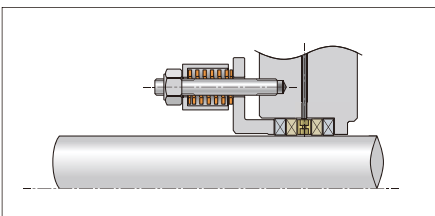

- Basic type of Live Loading Seal Unit
- In this structure, all gland packings are tightened onto a single gland follower.

Double gland type

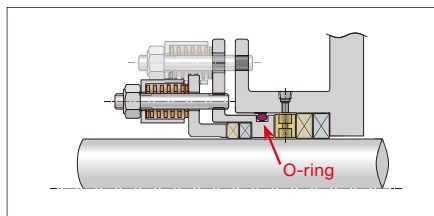

- In this structure, gland packings for use as primary and secondary seals are tightened onto different gland followers, providing excellent sealability.
- The secondary seal can follow shaft runout within the range of O-ring displacement.

Floating gland type

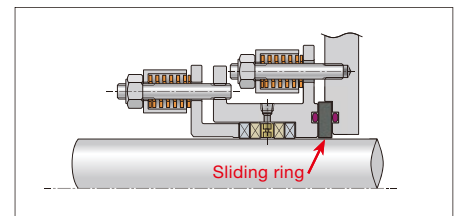

- The entire seal box, containing gland packings, slides on the sliding ring, enabling the seal box to follow shaft runout extremely well.

Gland packing selection examples

Powder/resin fluids No.4526L+No.4536



No.4536 (Adapter) No.4526L (Main)

This combination provides superb mechanical strength by allocating No. 4526L, which impregnates resilient aramid fibers with PTFE resin and heat-resistant liquid lubricating oil and provides excellent sealability, to the main packing and by allocating No. 4536, which impregnates special aramid fibers with liquid PTFE resin and can also be used in dry conditions, to the adapter packing.

Clean fluids No.4536+No.4504



No.4504 (Adapter) No.4536 (Main)

This combination considers contamination by allocating No. 4504, made up of PTFE only, to the adapter packing and by allocating No. 4536, which impregnates special aramid fibers with liquid PTFE resin and can also be used in dry conditions, to the main packing.

Chemical No.4525L+No.4525

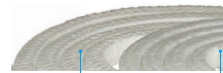

No.4525 (Adapter) No.4525L (Main)

This combination allocates gland packings made up of PTFE fibers with superb corrosion resistance to both the main packing and adapter packing.

High-temperature dry gases No.6527L+No.6722



No.6722 (Adapter) No.6527L (Main)

This combination allocates No. 6527L, which impregnates carbon fibers with special lubricant, to the main packing and provides excellent heat resistance and chemical resistance, and allocates No. 6722, made up of special flexible graphite yarn reinforced with aramid fibers, to the adapter packing. This is suitable for high-temperature gases.

<Notes on considering PILLAR LIVE LOADING SEAL UNIT™>

PILLAR LIVE LOADING SEAL UNITS are custom-designed products.

With regard to design, the customer must notify us of the following items:

- ① Device to be used: Device name, specific functions, etc.
- ② Detailed dimensions of shaft seal: Peripheral dimensions of shaft seal and spatial dimensions of the section in which a Live Loading Seal Unit is to be installed
- ③ Device operating conditions: Fluid, pressure, humidity, shaft diameter, rotational speed, amount of shaft runout, amount of eccentricity, shaft inclination, motor output, etc.

Notes on PILLAR LIVE LOADING SEAL UNIT operation

The PILLAR LIVE LOADING SEAL UNIT is individually optimally designed according to the various kinds of information received from the customer. We also present delivery specifications (drawings).

For actual use, this product must be operated and managed in accordance with the matters specified in the delivery specifications, such as installation management and retightening management.

GLAND PACKING

No.6501L

Pump

Stem tube

Carbonized fiber packing for pumps



This product is a versatile gland packing that is manufactured by making a square braid of carbonized fibers and impregnating it with PTFE dispersion and special lubricant.

- Excellent sealing performance
- Superior flexibility and excellent affinity with shafts
- Very little shaft wear

■ Specification conditions

Pump				pH range
Fluid temperature	Maximum operating pressure	Peripheral velocity	PV value	
0 to +200°C*	1.0MPaG	20m/s max.	9.8MPaG·m/s max.	2 to 12

* Any fluid exceeding +80°C must be cooled.

GLAND PACKING

No.6502L

Pump

Carbonized fiber packing for pumps



This product is gland packing that is manufactured by making a square braid of carbonized fibers impregnated with PTFE dispersion.

- Best suited for building air conditioner pumps on which head pressure acts, and other similar pumps
- Very little shaft wear

■ Specification conditions

Pump				pH range
Fluid temperature	Maximum operating pressure	Peripheral velocity	PV value	
0 to +200°C*	1.2MPaG	10m/s max.	9.8MPaG·m/s max.	2 to 12

* Any fluid exceeding +80°C must be cooled.

GLAND PACKING

No.6521L

Pump

Carbonized fiber packing for pumps



This product is gland packing that is manufactured by making an interlocking braid of carbonized fibers impregnated with PTFE dispersion and special lubricant.

- High pressure resistance and reduced effects on sealing performance even in the case of pump pressure fluctuations
- Stable sealing performance even with large-diameter shafts
- Very little shaft wear

■ Specification conditions

Pump				pH range
Fluid temperature	Maximum operating pressure	Peripheral velocity	PV value	
0 to +200°C*	1.2MPaG	20m/s max.	9.8MPaG·m/s max.	2 to 12

* Any fluid exceeding +80°C must be cooled.

GLAND PACKING

No.6527

Low-speed rotary machine

Carbon fiber packing for low-speed rotary machines



This product is gland packing that is manufactured by making an interlocking braid of carbon fibers and impregnating it with special lubricant.

- Excellent heat resistance and chemical resistance

■ Specification conditions

Low-speed rotary machine			pH range
Fluid temperature	Maximum operating pressure	Peripheral velocity	
+350°C max.	3.9MPaG	1 m/s max.	0 to 14

GLAND PACKING

No.6527L

Pump

Low-speed rotary machine

Carbon fiber packing for rotary machines



This product is gland packing that is manufactured by making an interlocking braid of carbon fibers and impregnating it with special lubricant.

- Excellent heat resistance and chemical resistance

■ Specification conditions

Pump				Low-speed rotary machine			pH range
Fluid temperature	Maximum operating pressure	Peripheral velocity	PV value	Fluid temperature	Maximum operating pressure	Peripheral velocity	
0 to +350°C*	1.6MPaG	10m/s max.	9.8MPaG·m/s max.	+350°C max.	3.9MPaG	1 m/s max.	0 to 14

* Any fluid exceeding +80°C must be cooled.

GLAND PACKING

No.6527S

Plunger pump

Carbon fiber packing for plunger pumps



This product is an endless type gland packing that is manufactured by making an interlocking braid of carbon fibers impregnated with graphite and PTFE dispersion and forming it to a specified size so that there is no cut end.

- Gland packing specifically developed for plunger pumps
- Significantly improved sealability, heat resistance, longevity, and other features, compared with conventional gland packings and V-shaped molded packings
- Excellent heat resistance and chemical resistance

■ Specification conditions

Plunger pump				pH range
Fluid temperature	Maximum operating pressure	Peripheral velocity	PV value	
-200 to 300°C*	29.4MPaG	1.2m/s max.	24.5MPaG·m/s max.	0 to 14

* Any fluid exceeding +80°C must be cooled.

GLAND PACKING

No.4526L

Aramid fiber packing for rotary machines

Pump

Low-speed
rotary machine

Soot blower



This product is gland packing that is manufactured by impregnating superior-strength aramid fibers with PTFE dispersion and special lubricant and making them into interlocking braids.

- This product is made of high-strength aramid fibers to provide excellent chemical resistance, as well as resistance to fluids containing slurry.
- The adoption of interlocking braids has made the packing extremely flexible, enabling even contact with the shaft, providing excellent sealability and long-term stability.

Specification conditions

Pump				Low-speed rotary machine			pH range
Fluid temperature	Maximum operating pressure	Peripheral velocity	PV value	Fluid temperature	Maximum operating pressure	Peripheral velocity	
0 to +260°C*	1.6MPaG	16m/s max.	14.7MPaG·m/s max.	+260°C max.	3.9MPaG	1 m/s max.	2 to 14

* Any fluid exceeding +80°C must be cooled.

GLAND PACKING

No.4536W

Aramid fiber packing for rotary machines

Low-speed
rotary machine

This product is gland packing that is manufactured by employing a center core that is made up of superior-strength inorganic fibers and an outer layer that is made up of interlock-braided yarn covered with flexible, low-elasticity aramid fibers, impregnated with PTFE dispersion.

- A white adapter packing that is made up of only white materials for applications that must be free from contamination

Specification conditions

Low-speed rotary machine		pH range
Fluid temperature	Maximum operating pressure	
+260°C max.	3.9MPaG	2 to 13

GLAND PACKING

No.4536WL

Aramid fiber packing for rotary machines

Pump

Low-speed
rotary machine

This product is gland packing that is manufactured by employing a center core that is made up of superior-strength inorganic fibers and an outer layer that is made up of interlock-braided yarn covered with flexible, low-elasticity aramid fibers, impregnated with PTFE dispersion and lubricant.

- A white gland packing that can also be used for fluids (applications) that must be free from contamination
- Providing both adaptivity and resiliency, causing little leakage or heat generation, and ensuring long-term stable sealability
- Best suited for various liquid chemicals (white liquor, green liquor, and black liquor) used in the paper making market
- Lineup of No. 4536WL-S with increased flexibility

Specification conditions

Pump				Low-speed rotary machine			pH range
Fluid temperature	Maximum operating pressure	Peripheral velocity	PV value	Fluid temperature	Maximum operating pressure	Peripheral velocity	
0 to +260°C*	1.0MPaG	10m/s max.	6.5MPaG·m/s max.	+260°C max.	3.9MPaG	1 m/s max.	2 to 13

* Any fluid exceeding +80°C must be cooled.

GLAND PACKING

No.4536

Aramid fiber packing for rotary machines

Low-speed
rotary machine

Soot blower



This product is gland packing that is manufactured by impregnating special aramid fibers with PTFE dispersion and making them into interlocking braids.

- The adoption of interlocking braids has made the packing extremely flexible, enabling even contact with the shaft, making it difficult to seize. Therefore, this product is best suited for low-speed dry applications.

Specification conditions

Low-speed rotary machine			Valve			pH range
Fluid temperature	Maximum operating pressure	Peripheral velocity	Fluid temperature	Maximum operating pressure	Pressure class	
+200°C max.	3.9MPaG	1m/s max.	0 to +200°C	10.3MPaG	Class 600 or lower	2 to 14

GLAND PACKING

No.4536L

Aramid fiber packing for rotary machines

Pump



This product is gland packing that is manufactured by making an interlocking braid of special aramid fibers and impregnating it with PTFE dispersion and special lubricant.

- Used for high-pressure, high-peripheral-velocity pumps
- Normally used in combination with No. 4526L. (Lineup of ring-formed products only)

Specification conditions

Pump			PV value	pH range
Fluid temperature	Maximum operating pressure	Peripheral velocity		
0 to +200°C*1	1.0MPaG	16m/s max.*2	10MPaG·m/s max.*3	2 to 14

*1 Any fluid exceeding +80°C must be cooled.

*2 Cooling is required when the peripheral velocity is 10 m/s or more.

*3 Cooling is required when the PV value is 6 or more.

GLAND PACKING

No.4504

PILAFLOTM fiber packing

Valve

Low-speed
rotary machine

This product is gland packing that is manufactured by impregnating PTFE fibers with PTFE dispersion and making them into square braids.

- Best suited for fluids that do not contain grease and must be free from contamination

Specification conditions

Valve			pH range
Fluid temperature	Maximum operating pressure	Pressure class	
0 to +200°C	10.3MPaG	Class 600 or lower	0 to 14

GLAND PACKING

No.4505L

PILAFLON™ fiber packing

Pump

Valve



This product is gland packing that is manufactured by making a square braid of PTFE fibers and impregnating it with PTFE dispersion and chemical-resistant lubricant.

- Mainly made up of PTFE fibers to secure various characteristics (such as sealing performance and slidability on shafts) in a balanced way

Specification conditions

Pump				Valve			pH range
Fluid temperature	Maximum operating pressure	Peripheral velocity	PV value	Fluid temperature	Maximum operating pressure	Pressure class	
0 to +260°C*	1.0MPaG	10m/s max.	4.9MPaG·m/s max.	-29 to +260°C	10.3MPaG	Class 600 or lower	0 to 14

* Any fluid exceeding +80°C must be cooled.

GLAND PACKING

No.4535L

PILAFLON™ fiber packing

Plunger pump

Valve

Pump



This product is gland packing that is manufactured by making an interlocking braid of PTFE fibers and impregnating it with special lubricant.

- A general-purpose packing that can be used not only for plunger pumps, but also for valves and rotary machines
- Mainly made up of PTFE fibers to provide excellent chemical resistance
- A white packing that can be used for fluids that must be free from contamination

Specification conditions

Plunger pump				Pump				Valve			pH range
Fluid temperature	Maximum operating pressure	Peripheral velocity	PV value	Fluid temperature	Maximum operating pressure	Peripheral velocity	PV value	Fluid temperature	Maximum operating pressure	Pressure class	
0 to +200°C*	10.0MPaG	1.2m/s max.	12.0MPaG·m/s max.	0 to +200°C*	0.8MPaG	8m/s max.	4.9MPaG·m/s max.	-29 to +260°C	10.3MPaG	Class 600 or lower	0 to 14

* Any fluid exceeding +80°C must be cooled.

GLAND PACKING

No.4525

PILAFLON™ fiber packing

Valve

Low-speed rotary machine



This product is gland packing that is manufactured by making an interlocking braid of PTFE fibers and impregnating it with PTFE dispersion.

- Interlock-braided to provide a rigid structure
- A versatile PTFE packing with resistance to chemical fluids

Specification conditions

Valve			Low-speed rotary machine			pH range
Fluid temperature	Maximum operating pressure	Pressure class	Fluid temperature	Maximum operating pressure	Peripheral velocity	
-29 to +260°C	10.3MPaG	Class 600 or lower	+260°C max.	3.9MPaG	1m/s max.	0 to 14

GLAND PACKING

No.4525L

PILAFLON™ fiber packing

Pump

Low-speed rotary machine



This product is gland packing that is manufactured by impregnating PTFE fibers with PTFE dispersion and special lubricant and making them into interlocking braids.

- The adoption of interlocking braids has made the packing extremely flexible, enabling even contact with the shaft, providing long-term stable sealability.

Specification conditions

Pump				Low-speed rotary machine			pH range
Fluid temperature	Maximum operating pressure	Peripheral velocity	PV value	Fluid temperature	Maximum operating pressure	Peripheral velocity	
0 to +200°C*	1.0MPaG	10m/s max.	4.9MPaG·m/s max.	+260°C max.	3.9MPaG	1 m/s max.	0 to 14

* Any fluid exceeding +80°C must be cooled.

GLAND PACKING

No.4527L

PILAFLON™ fiber packing

Pump



This product is gland packing that is manufactured by using PTFE fibers containing high-purity graphite and chemical-resistant lubricant and making them into interlocking braids.

- The adoption of interlocking braids has made the packing extremely flexible, enabling even contact with the shaft, providing excellent sealability and long-term stability.
- Best suited for chemical pumps

Specification conditions

Pump				pH range
Fluid temperature	Maximum operating pressure	Peripheral velocity	PV value	
0 to +260°C*	2.0MPaG	20m/s max.	12.3MPaG·m/s max.	0 to 14

* Any fluid exceeding +80°C must be cooled.

GLAND PACKING

No.6507

Carbon fiber packing

Valve

Low-speed rotary machine



This product is gland packing that is manufactured by impregnating carbon fibers with PTFE dispersion and making them into square braids.

- Excellent heat resistance and chemical resistance, available for a wide range of applications

Specification conditions

Valve			Low-speed rotary machine			pH range
Fluid temperature	Maximum operating pressure	Pressure class	Fluid temperature	Maximum operating pressure	Peripheral velocity	
-200 to +260°C	10.3MPaG	Class 600 or lower	+260°C max.	3.9MPaG	1 m/s max.	0 to 14

GLAND PACKING

No.6722

Low-speed rotary machine

Valve

PILLARFOIL™ yarn braided packing for low-speed rotary machines



This product is gland packing that is manufactured by making an interlocking braid of flexible graphite braided yarn reinforced with aramid fibers and impregnating it with special lubricant.

- Used for low-speed rotary machines and general-purpose valves

Specification conditions

Valve			Low-speed rotary machine			pH range
Fluid temperature	Maximum operating pressure	Pressure class	Fluid temperature	Maximum operating pressure	Peripheral velocity	
-200 to +350°C	10.3MPaG	Class 600 or lower	+350°C max.	3.9MPaG	1m/s max.	0 to 14

GLAND PACKING

No.6733

Pump

PILLARFOIL™ yarn braided packing for rotary machines



This product is gland packing that is manufactured by making an interlocking braid of flexible graphite braided yarn reinforced with aramid fibers and impregnating it with special lubricant.

Specification conditions

Pump				pH range
Fluid temperature	Maximum operating pressure	Peripheral velocity	PV value	
0 to +350°C*	2.0MPaG	20m/s max.	19.6MPaG·m/s max.	0 to 14

* Any fluid exceeding +80°C must be cooled.

GLAND PACKING

No.6615

Pump

PILLARFOIL™ molded packing for rotary machines



This product is gland packing that is manufactured by molding a flexible graphite sheet into a ring shape and cutting it in half.

Specification conditions

Pump				pH range
Fluid temperature	Maximum operating pressure	Peripheral velocity	PV value	
0 to +350°C*	2.0MPaG	20m/s max.	24.5MPaG·m/s max.	0 to 14

* Any fluid exceeding +80°C must be cooled.

No.426

Ramie packing for stern tube shafts



This product is gland packing that is manufactured by impregnating ramie fibers with white grease and making them into square braids.

- Generally and widely used as stern tube shaft seals

Specification conditions

		Pump		pH range
Fluid temperature	Maximum operating pressure	Peripheral velocity	PV value	
0 to +80°C	0.5MPaG	10m/s max.	2.5MPaG·m/s max.	6 to 8

No.426F

PTFE resin-impregnated ramie packing for stern tube shafts



This product is gland packing that is manufactured by impregnating ramie fibers with PTFE dispersion and white grease and making them into square braids.

- Balanced sealing performance, low friction on shafts, and fiber strength best suited for the needs of stern tube shaft seals
- Usable not only for stern tubes, but also for a large number of ship components, including general-purpose pumps for ships

Specification conditions

		Pump		pH range
Fluid temperature	Maximum operating pressure	Peripheral velocity	PV value	
0 to +80°C	0.6MPaG	10m/s max.	3.4MPaG·m/s max.	6 to 8



This product is a dedicated tool set for replacing packing easily.
 ● Applicable packing size: 6.5 mm to 12.5 mm

■ Components

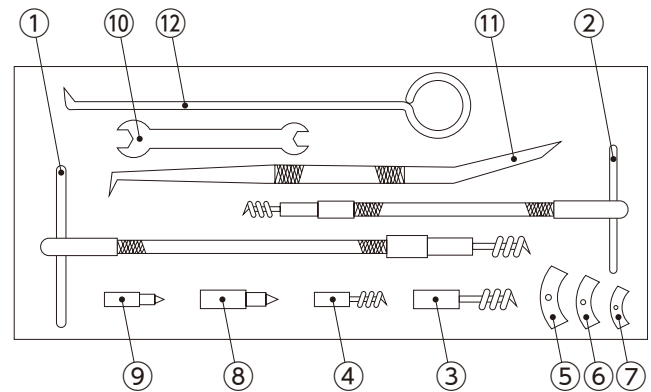

No.	Part name	Qty
1	Packing tool for up to 12.5 mm size (reference)	2
2	Packing tool for 6.5 to 9.5 mm size (reference)	2
3	Screw tip: Large	1
4	Screw tip: Small	1
5	Damper: Large	1
6	Damper: Medium	1
7	Damper: Small	1
8	Damper mounting jig: Large	2
9	Damper mounting jig: Small	2
10	Wrench	1
11	Bolt-hole aligner	1
12	Packing puller	1



This product is a dedicated tool for pulling packing easily.
 ● Lineup of products for different packing sizes

■ Lineup of products in different sizes

Model	Applicable packing size (reference)
A-2	3
A-4	5
A-6	5
A-8	6.5
A-10	6.5
A-12	6.5
A-14	8
A-16	8
A-18	9.5 to 11
A-19	14.5 or more
A-20	12.5



PILLAR NIPPON PILLAR PACKING CO., LTD.

Head office/Sales Headquarters
7-1, Shinmachi 1-chome, Nishi-ku, Osaka 550-0013, Japan
Phone: +81-6-7166-8326 Fax: +81-6-7166-8514

Email : sales@pillar.co.jp

<https://www3.pillar.co.jp/en/product/>



 Safety precaution	● When using this product, please use correctly and pay sufficient attention to safety.
--	---

* Please understand that this catalog may change without prior notice.
* The values shown on this catalog are reference values, not guaranteed values.

